



**MICROTRK1PCB30CM**

[ Acabado Negro 30 cm ]

**MICROTRK1PCB90CM**

[ Acabado Negro 90 cm ]



<b>Material</b>	Aluminio acabado negro
<b>Funciones</b>	Micro track magnético electrificado con 1 pista lateral, 30 o 90 cm de longitud, protección IP20
<b>Alimentación</b>	24 V cc 120 W (5 A) máx.



**COLEMICROT180B**

Cople de 180° mecánico y electrificado acabado negro, para micro track magnético

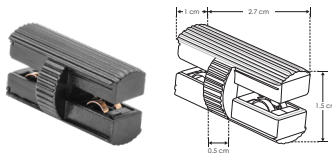

**ENDCAPMICROTB**

Tapa final acabado negro para micro track magnético. Incluye conector para fuente de poder.

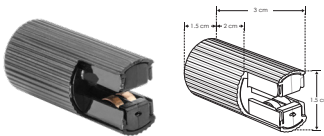

**BASLATMICROTB**

Base de sujeción lateral dirigible acabado negro para micro track magnético.

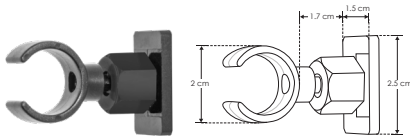

**BASLATMICROTB**

Base de sujeción lateral acabado negro para micro track magnético.

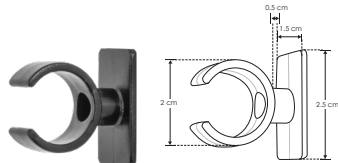

**COLEMICROT90B**

Cople de 90° mecánico y electrificado acabado negro, para micro track magnético.

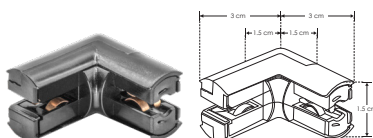

**BASINFMICROTB**

Base de sujeción inferior acabado negro para micro track magnético. Incluye conector para fuente de poder.

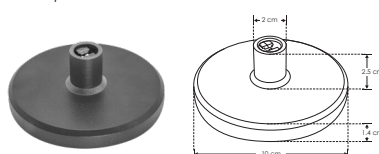

**ILUMICROF1WWWB**

[ Acabado negro (Blanco cálido) ]

Luminario de LED para micro track magnético, 24Vcc, 1W, 80lm, 120°

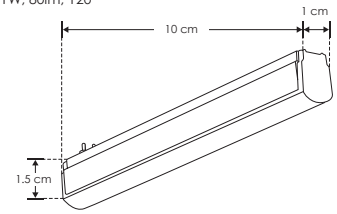

**ILUMICROD1WWWB**

[ Acabado negro (Blanco cálido) ]

Luminario de LED para micro track magnético, 24Vcc, 1W, 80lm, 24°

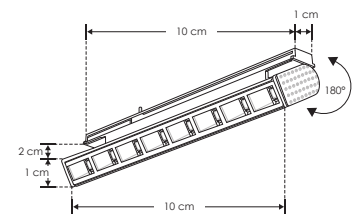

**ILUMICROSD1WWWB**

[ Acabado negro (Blanco cálido) ]

Luminario de LED para micro track magnético, 24 Vcc, 1W, 80lm, 24°

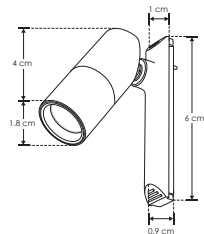

**ILUMICRO2SD2WWWB**

[ Acabado negro (Blanco cálido) ]

Luminario de LED para micro track magnético, 24Vcc, 2W, 160lm, 24°

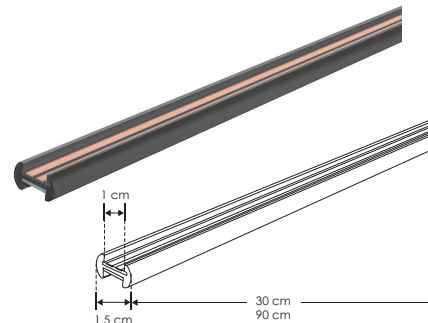
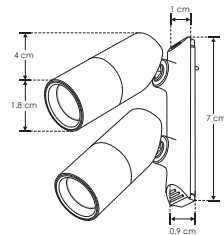

**24**  
Vcc  
SALIDA

**CRI 90**

**IP 20**