



MICROTRK1PCB30CM

[Acabado Negro 30 cm]

MICROTRK1PCB90CM

[Acabado Negro 90 cm]



COPLMICROT180B

Cople de 180° mecánico y electrificado acabado negro, para micro track magnético

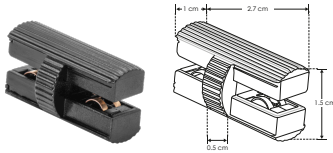

ENDCAPMICROTB

Tapa final acabado negro para micro track magnético. Incluye conector para fuente de poder.

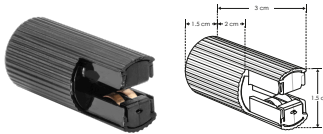

BASLATDMICROTB

Base de sujeción lateral dirigible acabado negro para micro track magnético.

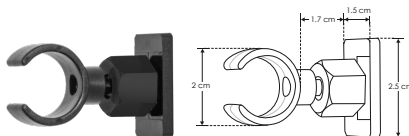

BASLATMICROTB

Base de sujeción lateral acabado negro para micro track magnético.

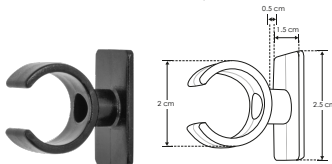

COPLMICROT90B

Cople de 90° mecánico y electrificado acabado negro, para micro track magnético.

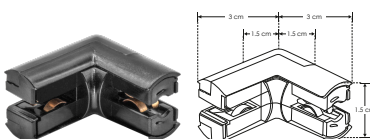

BASINFMICROTB

Base de sujeción inferior acabado negro para micro track magnético. Incluye conector para fuente de poder.

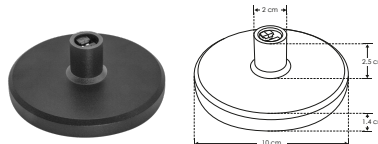

SOBREPONER / MICRO TRACK

Material

Aluminio acabado negro

Funciones

Micro track magnético electrificado con 1 pista lateral, 30 o 90 cm de longitud, protección IP20

Alimentación

24 V cc 120 W (5 A) máx.



ILUMICROF1WWWB

[Acabado negro (Blanco cálido)]

Luminario de LED para micro track magnético, 24Vcc, 1W, 80lm, 120°

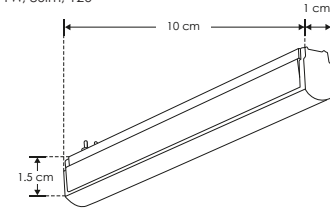

ILUMICROD1WWWB

[Acabado negro (Blanco cálido)]

Luminario de LED para micro track magnético, 24Vcc, 1W, 80lm, 24°

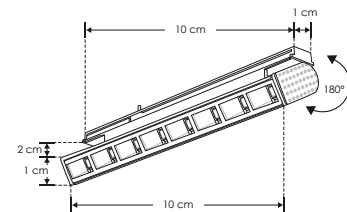

ILUMICROSD1WWWB

[Acabado negro (Blanco cálido)]

Luminario de LED para micro track magnético, 24 Vcc, 1W, 80lm, 24°

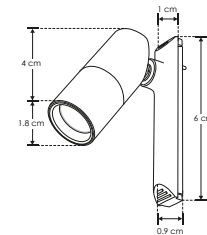

ILUMICRO2SD2WWWB

[Acabado negro (Blanco cálido)]

Luminario de LED para micro track magnético, 24Vcc, 2W, 160lm, 24°

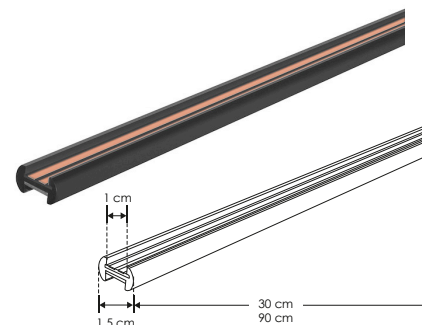
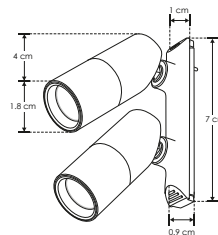

CRI 90

24 Vcc SALIDA

IP 20