



nuevo

**MICROTRK1PCB30CM**

[ Acabado Negro 30 cm ]  
Sobre pedido

**MICROTRK1PCB90CM**

[ Acabado Negro 90 cm ]  
Sobre pedido

<b>Material</b>	Aluminio acabado negro
<b>Funciones</b>	Micro track magnético electrificado con 1 pista lateral, 30 o 90 cm de longitud, protección IP20
<b>Alimentación</b>	24 V cc 120 W (5 A) máx.



**COPEMICROT180B**

Sobre pedido

Cople de 180° mecánico y electrificado acabado negro, para micro track magnético

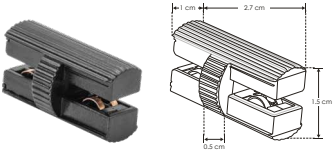

**ENDCAPMICROTB**

Sobre pedido

Tapa final acabado negro para micro track magnético. Incluye conector para fuente de poder.

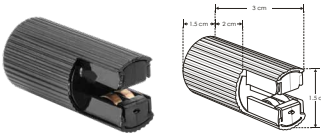

**BASLATDMICROTB**

Sobre pedido

Base de sujeción lateral dirigitable acabado negro para micro track magnético.

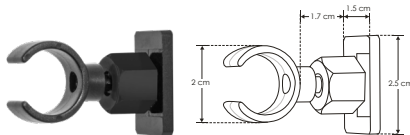

**BASLATMICROTB**

Sobre pedido

Base de sujeción lateral acabado negro para micro track magnético.

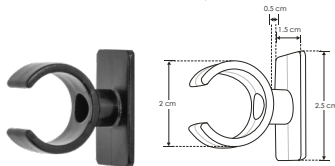

**COPEMICROT90B**

Sobre pedido

Cople de 90° mecánico y electrificado acabado negro, para micro track magnético.

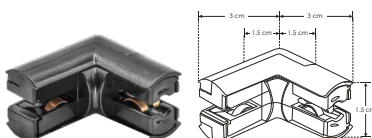

**BASINFMICROTB**

Sobre pedido

Base de sujeción inferior acabado negro para micro track magnético. Incluye conector para fuente de poder.

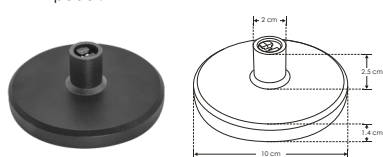

nuevo

**ILUMICROF1WWWB**

[ Acabado negro (Blanco cálido) ] Sobre pedido

Luminario de LED para micro track magnético

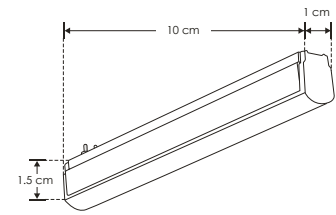

nuevo

**ILUMICROD1WWWB**

[ Acabado negro (Blanco cálido) ] Sobre pedido

Luminario de LED para micro track magnético

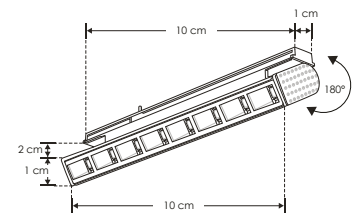

nuevo

**ILUMICROSD1WWWB**

[ Acabado negro (Blanco cálido) ] Sobre pedido

Luminario de LED para micro track magnético

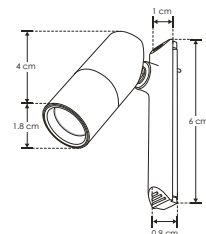

nuevo

**ILUMICRO2SD2WWWB**

[ Acabado negro (Blanco cálido) ] Sobre pedido

Luminario de LED para micro track magnético

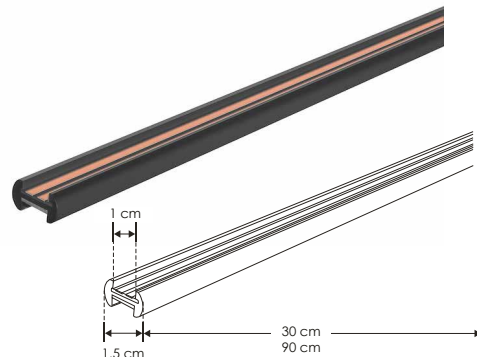
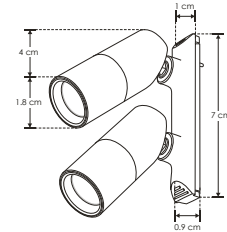

24

V cc SALIDA

IP 20